

Sunless Express® pre-installation guide

⚠ DANGER



Shock hazard.

Plug into a grounded 3-prong outlet.

Do not remove ground prong.

Do not use an adapter.

Disconnect power before servicing.

If the supply cord is damaged, it must be replaced by the manufacturer, its service agent or a similarly qualified person in order to avoid a hazard.

⚠ CAUTION

Read and follow all instructions regarding use and operation of the Sunless Express.

Unit intended FOR INDOOR USE ONLY.

Install this unit with a means for all-pole disconnect in accordance with local and/or national codes. We recommend electrical installation by a qualified electrician.

Tools Required

- Utility Knife
- Open-end wrenches in 1/2" and 5/8" sizes
- Allen (hex) wrenches in 1/8", 5/32", 3/16", 1/4", 3mm, 4mm and 5mm sizes
- Channel-lock Pliers
- Phillips screwdriver
- Flat-bladed Screwdriver
- Pry bar
- Screen bead roller
- Epoxy Gun (MIXPAC® Type DM 200-01-B or equivalent)
- Drill with 7/32" and 3/8" drill bits

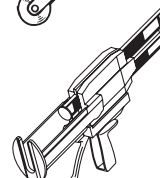
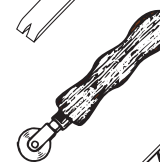
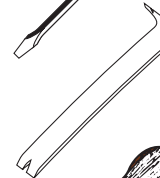
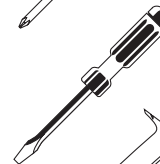
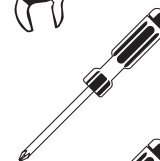
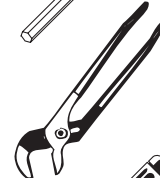
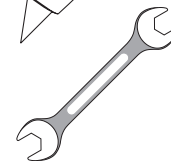
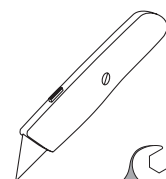

Facility Requirements

The Sunless Express® Spray Spa is a dynamic unit involving water, pressurized air and electricity, requiring special considerations in setup. The following amenities must be provided within easy access of the unit for proper operation:

The location must have:

- 7' x 9' room with 10' ceiling.
- ① 120 volt 15 amp service in the room. A 25' power cord, equipped with an integrated Ground Fault Circuit Interrupter, is supplied. See 'DANGER' statements on reverse.
 - ② Common cold municipal/residential water source to the room. Optimum supply pressure is 40-100 pounds per square inch. Hose connections require standard 3/4 - 11 1/2 American hose coupling threads (garden hose type). A 25' supply hose is supplied. Be sure not to kink the hose.

- ③ Drain with a minimum carry-away capacity of 1 gallon per minute. Be sure an airtight connection is NOT made between the drain hose and drain. The unit is equipped with a waste evacuation pump capable of sending water vertically 20' to allow routing of waste water over salon walls. A 25' drain hose is supplied. Be sure not to kink the hose.
- ④ The unit exhausts non-toxic tanning mist via a twenty foot long 8" flexible vent hose. Suitable vent structures may include air vent to outside or minimum air space of 200 ft³ above drop ceiling.

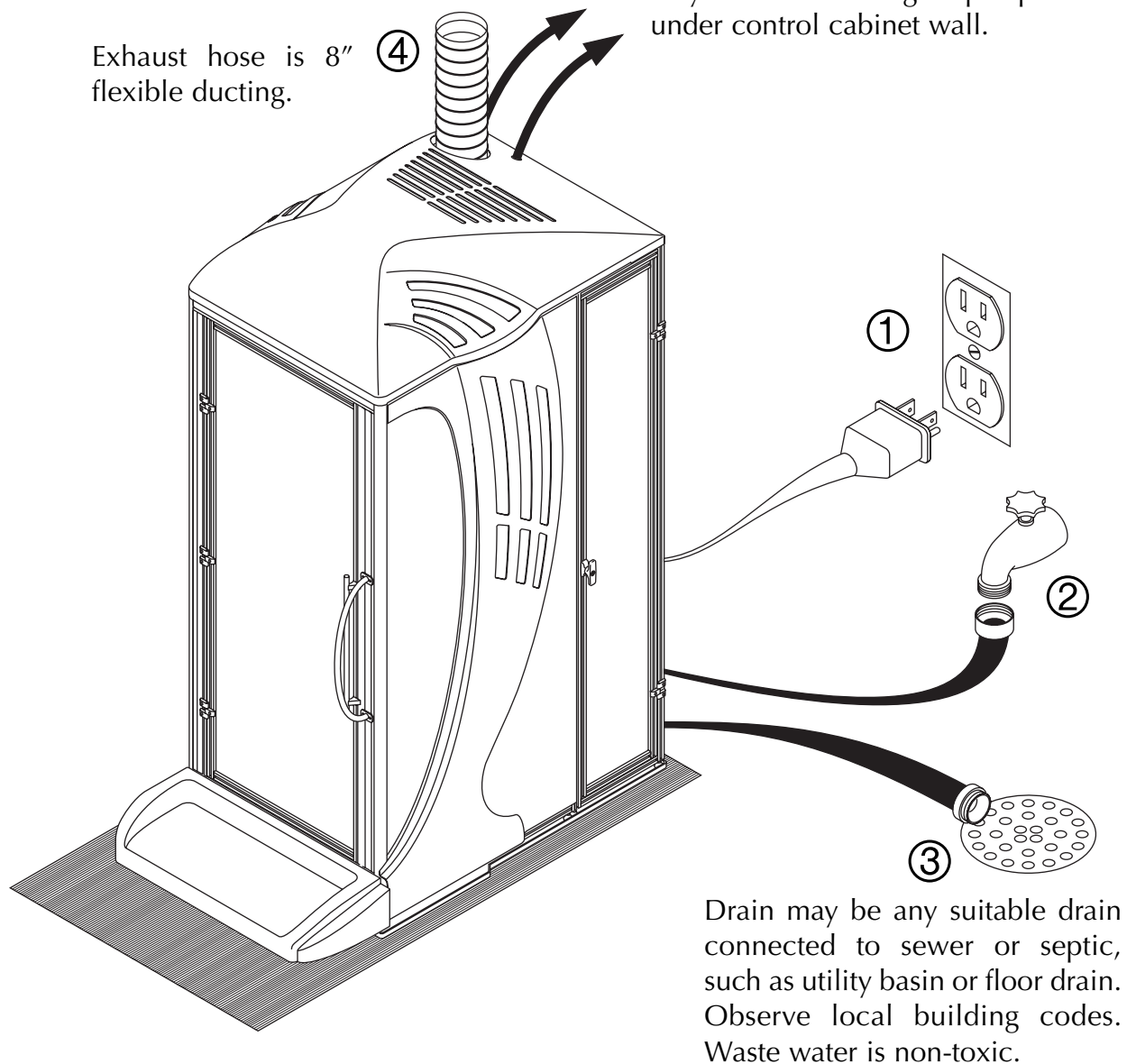

Sunless Express® Spray Spa

Size

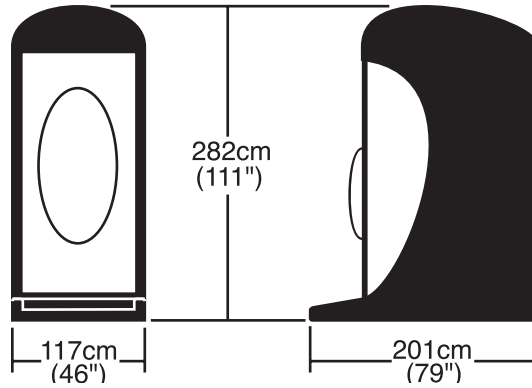

Weight

950 pounds / 431 kg

Minimum Room Size

7' (2.1 m) wide x 9' (2.7 m) long x 10' (3 m) tall

Electrical -

Voltage (AC)

120

Amperage

12

Outlet (NEMA standard)



5-15R

Remote Capability

T-Max® compatible

This product is in compliance with applicable requirements of UL 60335-1, IEC 335-2-23, and CAN/CSA-E335-1/3E-94.



88465



Record this information for ease of service:

Date of purchase: _____

Serial number: _____

CALL FOR SERVICE OR QUESTIONS:

1 • 877 • 783 • 8368

6270 Corporate Drive, Indianapolis, IN 46278-2900